

ROUGH WORK

**SB/
SX**

KVPY QUESTION PAPER – STREAM SB/SX

October 30, 2011

Part-I (1 Mark)

MATHEMATICS

1 Suppose $\log_a b + \log_b a = c$. The smallest possible integer value of c for all $a, b > 1$ is

- A. 4 B. 3
C. 2 D. 1

2 Suppose n is a natural number such that

$$|i + 2i^2 + 3i^3 + \dots + ni^n| = 18\sqrt{2},$$

where i is the square root of -1 . Then n is

- A. 9 B. 18
C. 36 D. 72

3 Let P be an $m \times m$ matrix such that $P^2 = P$. Then $(I + P)^n$ equals

- A. $I + P$ B. $I + nP$
C. $I + 2^n P$ D. $I + (2^n - 1)P$

4 Consider the cubic equation $x^3 + ax^2 + bx + c = 0$, where a, b, c are real numbers. Which of the following statements is correct?

- A. If $a^2 - 2b < 0$, then the equation has one real and two imaginary roots
- B. If $a^2 - 2b \geq 0$, then the equation has all real roots
- C. If $a^2 - 2b > 0$, then the equation has all real and distinct roots
- D. If $4a^3 - 27b^2 > 0$, then the equation has real and distinct roots

5 All the points (x, y) in the plane satisfying the equation $x^2 + 2x \sin(xy) + 1 = 0$ lie on

- A. a pair of straight lines
- B. a family of hyperbolas
- C. a parabola
- D. an ellipse

6 Let $A = (4, 0)$, $B = (0, 12)$ be two points in the plane. The locus of a point C such that the area of triangle ABC is 18 sq. units is

- A. $(y + 3x + 12)^2 = 81$
- B. $(y + 3x + 81)^2 = 12$
- C. $(y + 3x - 12)^2 = 81$
- D. $(y + 3x - 81)^2 = 12$

7 In a rectangle $ABCD$, the coordinates of A and B are $(1, 2)$ and $(3, 6)$ respectively and some diameter of the circumscribing circle of $ABCD$ has equation $2x - y + 4 = 0$. Then the area of the rectangle is

- A. 16
- B. $2\sqrt{10}$
- C. $2\sqrt{5}$
- D. 20

8 In the xy -plane, three distinct lines l_1, l_2, l_3 concur at a point $(\lambda, 0)$. Further the lines l_1, l_2, l_3 are normals to the parabola $y^2 = 6x$ at the points $A = (x_1, y_1)$, $B = (x_2, y_2)$, $C = (x_3, y_3)$ respectively. Then we have

- A. $\lambda < -5$
- B. $\lambda > 3$
- C. $-5 < \lambda < -3$
- D. $0 < \lambda < 3$

9 Let $f(x) = \cos 5x + A \cos 4x + B \cos 3x + C \cos 2x + D \cos x + E$, and

$$T = f(0) - f\left(\frac{\pi}{5}\right) + f\left(\frac{2\pi}{5}\right) - f\left(\frac{3\pi}{5}\right) + \dots + f\left(\frac{8\pi}{5}\right) - f\left(\frac{9\pi}{5}\right)$$

Then T

- A. depends on A, B, C, D, E
- B. depends on A, C, E , but independent of B and D
- C. depends on B, D , but independent of A, C, E
- D. is independent of A, B, C, D, E

10 In triangle ABC , we are given that $3\sin A + 4\cos B = 6$ and $4\sin B + 3\cos A = 1$. Then the measure of the angle C is

- A. 30° B. 150°
 C. 60° D. 75°

11 Which of the following intervals is a possible domain of the function $f(x) = \log_{[x]}[x] + \log_{\{x\}}\{x\}$, where $[x]$ is the greatest integer not exceeding x and $\{x\} = x - [x]$?

- A. $(0,1)$ B. $(1,2)$
 C. $(2,3)$ D. $(3,5)$

12 If $f(x) = (2011+x)^n$, where x is a real variable and n is a positive integer, then the value of

$$f(0) + f'(0) + \frac{f''(0)}{2!} + \dots + \frac{f^{(n-1)}(0)}{(n-1)!}$$

is

- A. $(2011)^n$ B. $(2012)^n$
 C. $(2012)^n - 1$ D. $n(2011)^n$

13 The minimum distance between a point on the curve $y = e^x$ and a point on the curve $y = \log_e x$ is

- A. $\frac{1}{\sqrt{2}}$ B. $\sqrt{2}$
 C. $\sqrt{3}$ D. $2\sqrt{2}$

14 Let $f: (2, \infty) \rightarrow \mathbb{N}$ be defined by $f(x) =$ the largest prime factor of $[x]$. Then $\int_2^8 f(x) dx$ is equal to

- A. 17 B. 22
 C. 23 D. 25

15 Let $[x]$ denote the largest integer not exceeding x and $\{x\} = x - [x]$. Then

$$\int_0^{2012} \frac{e^{\cos(\pi\{x\})}}{e^{\cos(\pi\{x\})} + e^{-\cos(\pi\{x\})}} dx$$

is equal to

- A. 0 B. 1006
 C. 2012 D. 2012π

- 16 The value of

$$\lim_{n \rightarrow \infty} \left(\frac{1}{\sqrt{4n^2 - 1}} + \frac{1}{\sqrt{4n^2 - 4}} + \dots + \frac{1}{\sqrt{4n^2 - n^2}} \right)$$

is

- A. $\frac{1}{4}$ B. $\frac{\pi}{12}$
 C. $\frac{\pi}{4}$ D. $\frac{\pi}{6}$

- 17 Two players play the following game: A writes 3, 5, 6 on three different cards; B writes 8, 9, 10 on three different cards. Both draw randomly two cards from their collections. Then A computes the product of two numbers he/she has drawn, and B computes the sum of two numbers he/she has drawn. The player getting the larger number wins. What is the probability that A wins?

- A. $\frac{1}{3}$ B. $\frac{5}{9}$
 C. $\frac{4}{9}$ D. $\frac{1}{9}$

- 18 Let $\vec{a}, \vec{b}, \vec{c}$ be three vectors in the xyz -space such that

$$\vec{a} \times \vec{b} = \vec{b} \times \vec{c} = \vec{c} \times \vec{a} \neq \vec{0}.$$

If A, B, C are points with position vectors $\vec{a}, \vec{b}, \vec{c}$ respectively, then the number of possible positions of the centroid of triangle ABC is

- A. 1 B. 2
 C. 3 D. 6

- 19 The sum of

$$(1^2 - 1 + 1)(1!) + (2^2 - 2 + 1)(2!) + \dots + (n^2 - n + 1)(n!)$$

is

- A. $(n+2)!$ B. $(n-1)((n+1)! + 1)$
 C. $(n+2)! - 1$ D. $n((n+1)! - 1)$

- 20 Let X be a nonempty set and let $P(X)$ denote the collection of all subsets of X . Define

$$f : X \times P(X) \rightarrow \mathbf{R} \text{ by}$$

$$f(x, A) = \begin{cases} 1, & \text{if } x \in A; \\ 0, & \text{if } x \notin A. \end{cases}$$

Then $f(x, A \cup B)$ equals

- A. $f(x, A) + f(x, B)$
 B. $f(x, A) + f(x, B) - 1$
 C. $f(x, A) + f(x, B) - f(x, A)f(x, B)$
 D. $f(x, A) + |f(x, A) - f(x, B)|$

PHYSICS

- 21 A narrow but tall cabin is falling freely near the earth's surface. Inside the cabin, two small stones A and B are released from rest (relative to the cabin). Initially A is much above the centre of mass and B much below the centre of mass of the cabin. A close observation of the motion of A and B will reveal that
- both A and B continue to be exactly at rest relative to the cabin.
 - A moves slowly upward and B moves slowly downward relative to the cabin.
 - both A and B fall to the bottom of the cabin with constant acceleration due to gravity.
 - A and B move slightly towards each other vertically.
- 22 Two plates each of mass m are connected by a massless spring as shown.

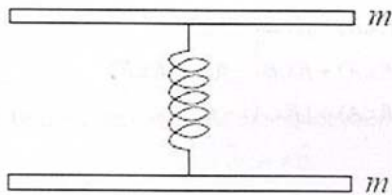

A weight W is put on the upper plate which compresses the spring further. When W is removed, the entire assembly jumps up. The minimum weight W needed for the assembly to jump up when the weight is removed is just more than

- mg
- $2mg$
- $3mg$
- $4mg$

- 23 If the speed (v) of the bob in a simple pendulum is plotted against the tangential acceleration (a), the correct graph will be represented by

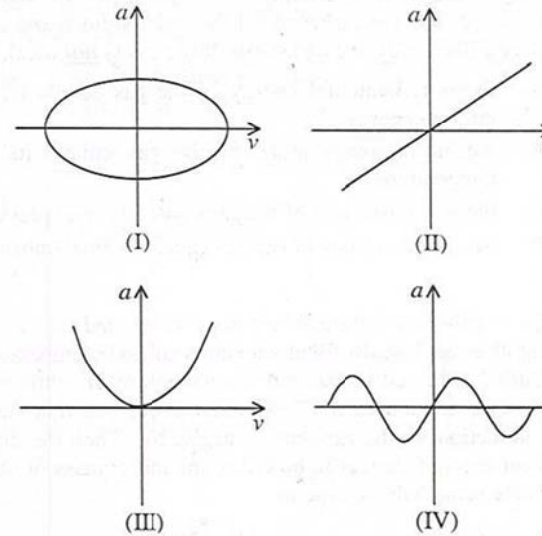

- I
- II
- III
- IV

- 24 A container with rigid walls is covered with perfectly insulating material. The container is divided into two parts by a partition. One part contains a gas while the other is fully evacuated (vacuum). The partition is suddenly removed. The gas rushes to fill the entire volume and comes to equilibrium after a little time. If the gas is not ideal,
- the initial internal energy of the gas equals its final internal energy
 - the initial temperature of the gas equals its final temperature
 - the initial pressure of the gas equals its final pressure
 - the initial entropy of the gas equals its final entropy
- 25 Two bulbs of identical volumes connected by a small capillary are initially filled with an ideal gas at temperature T . Bulb 2 is heated to maintain a temperature $2T$ while bulb 1 remains at temperature T . Assume throughout that the heat conduction by the capillary is negligible. Then the ratio of final mass of the gas in bulb 2 to the initial mass of the gas in the same bulb is close to
- $1/2$
 - $2/3$
 - $1/3$
 - 1
- 26 Two rods, one made of copper and the other steel of the same length and cross sectional area are joined together. (The thermal conductivity of copper is $385 \text{ J}\cdot\text{s}^{-1}\cdot\text{m}^{-1}\cdot\text{K}^{-1}$ and steel is $50 \text{ J}\cdot\text{s}^{-1}\cdot\text{m}^{-1}\cdot\text{K}^{-1}$.) If the copper end is held at 100°C and the steel end is held at 0°C , what is the junction temperature (assuming no other heat losses)?
- 12°C
 - 50°C
 - 73°C
 - 88°C

- 27 Jet aircrafts fly at altitudes above 30,000 ft where the air is very cold at -40°C and the pressure is 0.28 atm. The cabin is maintained at 1 atm pressure by means of a compressor which exchanges air from outside adiabatically. In order to have a comfortable cabin temperature of 25°C , we will require in addition:
- a heater to warm the air injected into the cabin
 - an air-conditioner to cool the air injected into the cabin
 - neither a heater nor an air-conditioner: the compressor is sufficient
 - alternatively heating and cooling in the two halves of the compressor cycle
- 28 A speaker emits a sound wave of frequency f_0 . When it moves towards a stationary observer with speed u , the observer measures a frequency f_1 . If the speaker is stationary, and the observer moves towards it with speed u , the measured frequency is f_2 . Then
- $f_1 = f_2 < f_0$
 - $f_1 > f_2$
 - $f_1 < f_2$
 - $f_1 = f_2 > f_0$
- 29 A plane polarized light passed through successive polarizers which are rotated by 30° with respect to each other in the clockwise direction. Neglecting absorption by the polarizers and given that the first polarizer's axis is parallel to the plane of polarization of the incident light, the intensity of light at the exit of the fifth polarizer is closest to
- same as that of the incident light
 - 17.5% of the incident light
 - 30% of the incident light
 - zero

30 At 23°C, a pipe open at both ends resonates at a frequency of 450 hertz. At what frequency does the same pipe resonate on a hot day when the speed of sound is 4 percent higher than it would be at 23°C?

- A. 446 Hz B. 454 Hz
C. 468 Hz D. 459 Hz

31 In a Young's double slit set-up, light from a laser source falls on a pair of very narrow slits separated by 1.0 micrometer and bright fringes separated by 1.0 millimeter are observed on a distant screen. If the frequency of the laser light is doubled, what will be the separation of the bright fringes?

- A. 0.25 mm B. 0.5 mm
C. 1.0 mm D. 2.0 mm

32 For a domestic AC supply of 220 V at 50 cycles per second, the potential difference between the terminals of a two-pin electric outlet in a room is given by

- A. $V(t) = 220\sqrt{2}\cos(100\pi t)$
B. $V(t) = 220\cos(50t)$
C. $V(t) = 220\cos(100\pi t)$
D. $V(t) = 220\sqrt{2}\cos(50t)$

33 In the circuit shown below the resistances are given in ohms and the battery is assumed ideal with emf equal to 3.0 volts. The resistor that dissipates the most power is

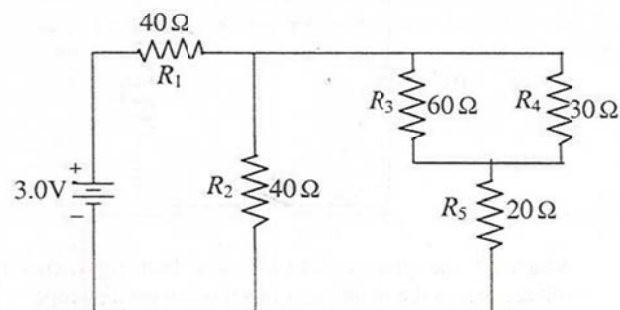

- A. R_1 B. R_2
C. R_3 D. R_4

34 An electron collides with a free molecule initially in its ground state. The collision leaves the molecule in an excited state that is metastable and does not decay to the ground state by radiation. Let K be the sum of the initial kinetic energies of the electron and the molecule, and \vec{P} the sum of their initial momenta. Let K' and \vec{P}' represent the same physical quantities after the collision. Then

- A. $K = K'$, $\vec{P} = \vec{P}'$ B. $K' < K$, $\vec{P} = \vec{P}'$
C. $K = K'$, $\vec{P} \neq \vec{P}'$ D. $K' < K$, $\vec{P} \neq \vec{P}'$

- 35 In the circuit shown, the switch is closed at time $t = 0$.

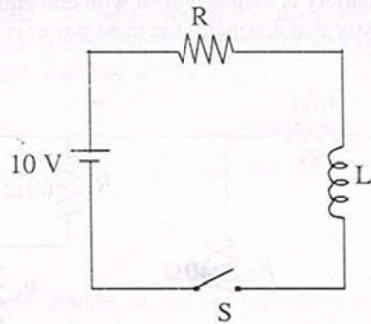

Which of the graphs shown below best represents the voltage across the inductor, as seen on an oscilloscope?

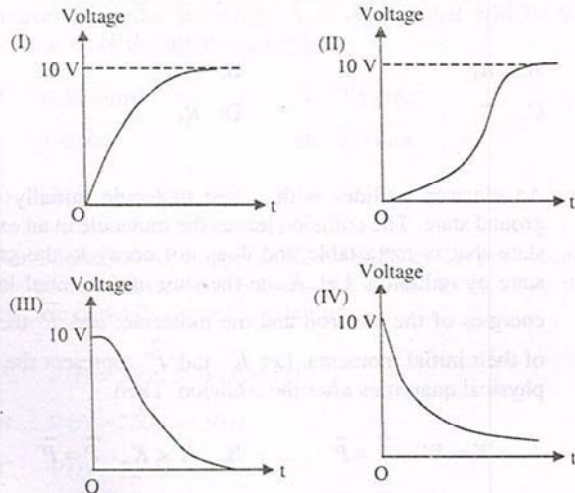

- A. I
B. II
C. III
D. IV

- 36 Given below are three schematic graphs of potential energy $V(r)$ versus distance r for three atomic particles: electron (e^-), proton (p^+) and neutron (n), in the presence of a nucleus at the origin O. The radius of the nucleus is r_0 . The scale on the V -axis may not be the same for all figures. The correct pairing of each graph with the corresponding atomic particle is

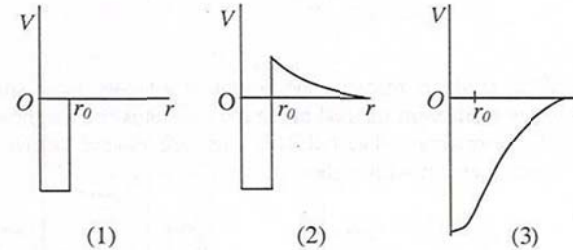

- A. (1, n), (2, p^+), (3, e^-)
B. (1, p^+), (2, e^-), (3, n)
C. (1, e^-), (2, p^+), (3, n)
D. (1, p^+), (2, n), (3, e^-)
- 37 Due to transitions among its first three energy levels, hydrogenic atom emits radiation at three discrete wavelengths λ_1 , λ_2 , and λ_3 ($\lambda_1 < \lambda_2 < \lambda_3$). Then
- A. $\lambda_1 = \lambda_2 + \lambda_3$
B. $\lambda_1 + \lambda_2 = \lambda_3$
C. $1/\lambda_1 + 1/\lambda_2 = 1/\lambda_3$
D. $1/\lambda_1 = 1/\lambda_2 + 1/\lambda_3$
- 38 The total radiative power emitted by spherical blackbody with radius R and temperature T is P . If the radius is doubled and the temperature is halved then the radiative power will be

- A. $P/4$
B. $P/2$
C. $2P$
D. $4P$

- 39 The Quantum Hall Resistance R_H is a fundamental constant with dimensions of resistance. If h is Planck's constant and e the electron charge, then the dimension of R_H is the same as

- A. e^2/h B. h/e^2
 C. h^2/e D. e/h^2

- 40 Four students measure the height of a tower. Each student uses a different method and each measures the height many different times. The data for each are plotted below. The measurement with highest precision is

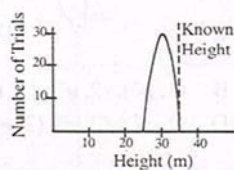

(I)

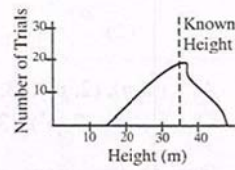

(II)

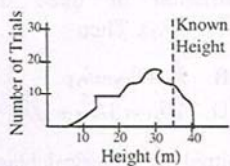

(III)

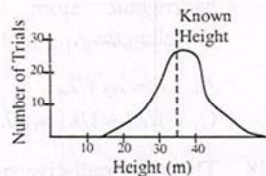

(IV)

- A. I B. II
 C. III D. IV

CHEMISTRY

- 41 The hybridizations of $\text{Ni}(\text{CO})_4$ and $\text{Cr}(\text{H}_2\text{O})_6^{2+}$, respectively, are

- A. sp^3 and d^3sp^2 B. dsp^2 and d^2sp^3
 C. sp^3 and d^2sp^3 D. dsp^2 and sp^3d^2

- 42 Extraction of silver is achieved by initial complexation of the ore (Argentite) with X followed by reduction with Y. X and Y, respectively, are

- A. CN^- and Zn B. CN^- and Cu
 C. Cl^- and Zn D. Br^- and Zn

- 43 Assuming ideal behaviour, the enthalpy and volume of mixing of two liquids, respectively, are

- A. zero and zero B. +ve and zero
 C. -ve and zero D. -ve and -ve

- 44 At 298 K, the ratio of osmotic pressures of two solutions of a substance with concentrations of 0.01 M and 0.001 M, respectively, is

- A. 1 B. 100
 C. 10 D. 1000

- 45 The rate of gas phase chemical reactions generally increases rapidly with rise in temperature. This is mainly because
- the collision frequency increases with temperature
 - the fraction of molecules having energy in excess of the activation energy increases with temperature
 - the activation energy decreases with temperature
 - the average kinetic energy of molecules increases with temperature

46 Among i-iv

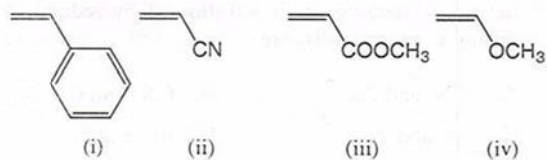

the compound that does not undergo polymerization under radical initiation, is

- i
 - ii
 - iii
 - iv
- 47 Two possible stereoisomers for

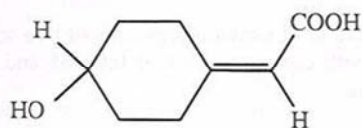

are

- enantiomers
- diastereomers
- conformers
- rotamers

- 48 For a process to occur spontaneously
- only the entropy of the system must increase
 - only the entropy of the surroundings must increase
 - either the entropy of the system or that of the surroundings must increase
 - the total entropy of the system and the surroundings must increase

- 49 When the size of a spherical nanoparticle decreases from 30 nm to 10 nm, the ratio surface area/volume becomes
- 1/3 of the original
 - 3 times the original
 - 1/9 of the original
 - 9 times the original

50 The major product of the following reaction is :

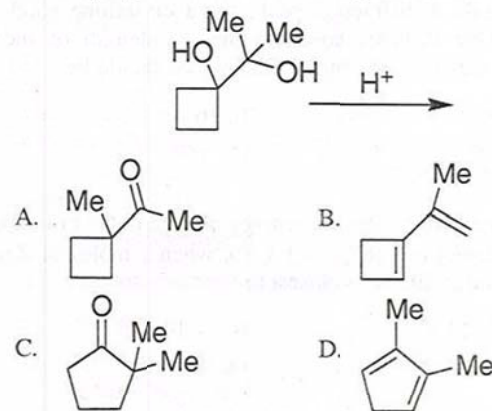

- 51 For the transformation

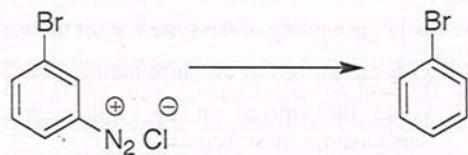

the reagent used is

- A. LiAlH_4 B. H_3PO_2
C. H_3O^+ D. H_2/Pt
- 52 The values of the limiting molar conductivity (Λ°) for NaCl , HCl and NaOAc are 126.4, 425.9 and $91.0 \text{ S cm}^2 \text{ mol}^{-1}$, respectively. For HOAc , Λ° in $\text{S cm}^2 \text{ mol}^{-1}$ is
- A. 390.5 B. 299.5
C. 208.5 D. 217.4
- 53 To obtain a diffraction peak, for a crystalline solid with interplane distance equal to the wavelength of incident X-ray radiation, the angle of incidence should be
- A. 90° B. 0°
C. 30° D. 60°
- 54 The standard Gibbs free energy change (ΔG° in kJ mol^{-1}), in a Daniel cell ($E^\circ_{\text{cell}} = 1.1 \text{ V}$), when 2 moles of Zn(s) is oxidized at 298 K, is closest to
- A. -212.3 B. -106.2
C. -424.6 D. -53.1

- 55 All the products formed in the oxidation of NaBH_4 by I_2 , are

- A. B_2H_6 and NaI B. B_2H_6 , H_2 and NaI
C. BI_3 and NaH D. NaBI_4 and HI

- 56 The spin-only magnetic moments of $[\text{Mn}(\text{CN})_6]^{4-}$ and $[\text{MnBr}_4]^{2-}$ in Bohr Magnetons, respectively, are

- A. 5.92 and 5.92 B. 4.89 and 1.73
C. 1.73 and 5.92 D. 1.73 and 1.73

- 57 In a zero-order reaction, if the initial concentration of the reactant is doubled, the time required for half the reactant to be consumed

- A. increases two-fold B. increases four-fold
C. decreases by half D. does not change

- 58 The adsorption isotherm for a gas is given by the relation $x = ap/(1+bp)$ where x is moles of gas adsorbed per gram of the adsorbent, p is the pressure of the gas, and a and b are constants. Then x

- A. increases with p
B. remains unchanged with p
C. decreases with p
D. increases with p at low pressures and then remains the same at high pressures

59 The reaction

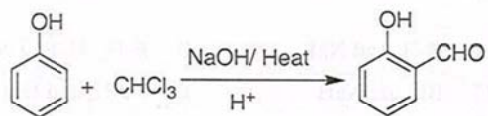

is known as

- A. Perkin reaction
- B. Sandmeyer reaction
- C. Reimer-Tiemann reaction
- D. Cannizzaro reaction

60 Among i-iii

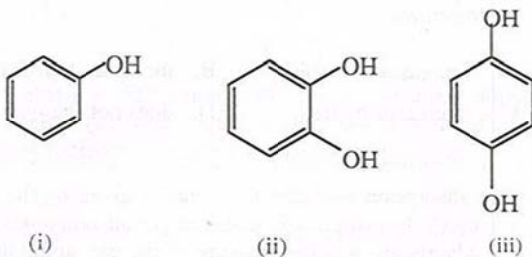

the boiling point follows the order

- A. ii < i < iii
- B. iii < ii < i
- C. i < ii < iii
- D. ii < iii < i

BIOLOGY

61 The major constituents of neurofilaments are

- A. microtubules
- B. intermediate filaments
- C. actin filaments
- D. protofilaments

62 In which phase of the cell cycle are sister chromatids available as template for repair?

- A. G1 phase
- B. G2 phase
- C. S Phase
- D. M phase

63 A person has difficulty in breathing at higher altitudes because

- A. oxygen is likely to diffuse from lungs to blood.
- B. oxygen is likely to diffuse from blood to lungs.
- C. partial pressure of O₂ is lower than partial pressure of CO₂.
- D. overall intake of O₂ by the blood becomes low.

64 In humans, the composition of a zygote that will develop into a female is

- A. 44A + XX
- B. 44A + XY
- C. 22 + X
- D. 23A

- 65 If you fractionate all the organelles from the cytoplasm of a plant cell, in which one of the following sets of fractions will you find nucleic acids?
- A. nucleus, mitochondria, chloroplast, cytoplasm
 - B. nucleus, mitochondria, chloroplast, glyoxysome
 - C. nucleus, chloroplast, cytoplasm and peroxisome
 - D. nucleus, mitochondria, chloroplast, Golgi bodies
- 66 A protein with 100 amino acid residues has been translated based on triplet genetic code. Had the genetic code been quadruplet, the gene that codes for the protein would have been:
- A. same in size
 - B. longer in size by 25%
 - C. longer in size by 100%
 - D. shorter in size
- 67 If the sequence of bases in DNA is 5'- ATGTATCTCAAT - 3', then the sequence of bases in its transcript will be:
- A. 5'- TACATAGAGTTA -3'
 - B. 5'- UACAUAGAGUUA -3'
 - C. 5'- AUGUAUCUCAAU -3'
 - D. 5'- AUUGAGAUACAU -3'
- 68 The Na^+/K^+ pump is present in the plasma membrane of mammalian cells where it
- A. expels potassium from the cell.
 - B. expels sodium and potassium from the cell.
 - C. pumps sodium into the cell.
 - D. expels sodium from the cell.

- 69 The CO_2 in the blood is mostly carried
- A. by haemoglobin in RBCs
 - B. in the cytoplasm of WBCs
 - C. in the plasma as bicarbonate ions
 - D. by plasma proteins
- 70 Patients who have undergone organ transplants are given anti-rejection medications to
- A. minimize infection
 - B. stimulate B-macrophage cell interaction
 - C. prevent T-lymphocyte proliferation
 - D. adopt the HLA of donor
- 71 Saline drip is given to a Cholera patient because
- A. NaCl kills *Vibrio cholera*
 - B. NaCl generates ATP
 - C. Na^+ ions stops nerve impulse and hence sensation of pain
 - D. Na^+ ions help in retention of water in body tissue
- 72 A water molecule can form a maximum of _____ hydrogen bonds.
- A. 1
 - B. 2
 - C. 3
 - D. 4

73 Circadian Rhythm is an endogenously driven cycle for biochemical, physiological and behavioral processes. In humans, the approximate duration of this 'biological clock' is:

- A. 1 Hour
- B. 6 Hours
- C. 12 Hours
- D. 24 Hours

74 Modern evolutionary theory consists of the concepts of Darwin modified by knowledge concerning:

- A. population statistics
- B. Mendel's laws
- C. the idea of the survival of the fittest
- D. competition

75 Soon after the three germ layers are formed in a developing embryo, the process of organogenesis starts. The human brain is formed from the

- A. ectoderm
- B. endoderm
- C. mesoderm
- D. partly endoderm and partly mesoderm

76 Puffs in the polytene chromosomes of *Drosophila melanogaster* salivary glands represent

- A. transcriptionally active genes
- B. transcriptionally inactive genes
- C. heterochromatin
- D. housekeeping genes

77 The process of cell death involving DNA cleavage in cells is known as

- A. necrosis
- B. apoptosis
- C. cytokinesis
- D. endocytosis

78 According to the original model of DNA, as proposed by Watson & Crick in 1953, DNA is a

- A. left handed helix
- B. helix that makes a full turn every 70 nm.
- C. helix where one turn of DNA contains 20 basepairs
- D. two stranded helix where each strand has opposite polarity.

79 At which stage of Meiosis I does crossing over occur?

- A. leptotene
- B. zygotene
- C. pachytene
- D. diplotene

80 An electrode is placed in the axoplasm of a mammalian axon and another electrode is placed just outside the axon. The potential difference measured will be

- A. 0
- B. -70 mV
- C. -70 μ V
- D. +70 μ V

Part-II (2 Marks)

MATHEMATICS

- 81 Let A and B be any two $n \times n$ matrices such that the following conditions hold: $AB = BA$ and there exist positive integers k and l such that $A^k = I$ (the identity matrix) and $B^l = O$ (the zero matrix). Then
- A. $A + B = I$
 - B. $\det(AB) = 0$
 - C. $\det(A + B) \neq 0$
 - D. $(A + B)^m = O$ for some integer m
- 82 The minimum value of n for which
- $$\frac{2^2 + 4^2 + 6^2 + \dots + (2n)^2}{1^2 + 3^2 + 5^2 + \dots + (2n-1)^2} < 1.01$$
- A. is 101
 - B. is 121
 - C. is 151
 - D. does not exist
- 83 The locus of the point $P = (a, b)$ where a, b are real numbers such that the roots of $x^3 + ax^2 + bx + a = 0$ are in arithmetic progression is
- A. an ellipse
 - B. a circle
 - C. a parabola whose vertex is on the y -axis
 - D. a parabola whose vertex is on the x -axis

- 84 The smallest possible positive slope of a line whose y -intercept is 5 and which has a common point with the ellipse $9x^2 + 16y^2 = 144$ is

- A. $\frac{3}{4}$
- B. 1
- C. $\frac{4}{3}$
- D. $\frac{9}{16}$

- 85 Let $A = \{\theta \in \mathbf{R} \mid \cos^2(\sin \theta) + \sin^2(\cos \theta) = 1\}$ and $B = \{\theta \in \mathbf{R} \mid \cos(\sin \theta) \sin(\cos \theta) = 0\}$. Then $A \cap B$

- A. is the empty set
- B. has exactly one element
- C. has more than one but finitely many elements
- D. has infinitely many elements

- 86 Let $f(x) = x^3 + ax^2 + bx + c$, where a, b, c are real numbers. If $f(x)$ has a local minimum at $x = 1$ and a local maximum

at $x = -\frac{1}{3}$ and $f(2) = 0$, then $\int_{-1}^1 f(x) dx$ equals

- A. $\frac{14}{3}$
- B. $-\frac{14}{3}$
- C. $\frac{7}{3}$
- D. $-\frac{7}{3}$

87 Let $f(x) = x^{12} - x^9 + x^4 - x + 1$. Which of the following is true?

- A. f is one-one
- B. f has a real root
- C. f' never vanishes
- D. f takes only positive values

88 For each positive integer n , define $f_n(x) = \text{minimum}\left(\frac{x^n}{n!}, \frac{(1-x)^n}{n!}\right)$, for $0 \leq x \leq 1$.

Let $I_n = \int_0^1 f_n(x) dx$, $n \geq 1$. Then $\sum_{n=1}^{\infty} I_n$ is equal to

- A. $2\sqrt{e} - 3$
- B. $2\sqrt{e} - 2$
- C. $2\sqrt{e} - 1$
- D. $2\sqrt{e}$

89 The maximum possible value of $x^2 + y^2 - 4x - 6y$, x, y real, subject to the condition $|x + y| + |x - y| = 4$

- A. is 12
- B. is 28
- C. is 72
- D. does not exist

90 The arithmetic mean and the geometric mean of two distinct 2-digit numbers x and y are two integers one of which can be obtained by reversing the digits of the other (in base 10 representation). Then $x + y$ equals

- A. 82
- B. 116
- C. 130
- D. 148

PHYSICS

91 An isolated sphere of radius R contains uniform volume distribution of positive charge. Which of the curves shown below correctly illustrates the dependence of the magnitude of the electric field of the sphere as a function of the distance r from its centre?

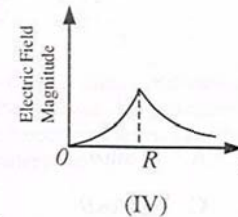
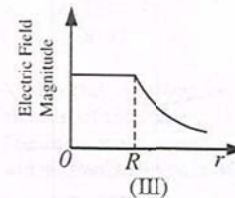
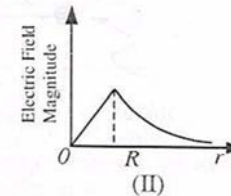
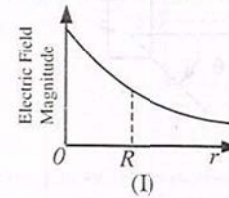

- A. I
- B. II
- C. III
- D. IV

92 The surface of a planet is found to be uniformly charged. When a particle of mass m and no charge is thrown at an angle from the surface of the planet, it has a parabolic trajectory as in projectile motion with horizontal range L . A particle of mass m and charge q , with the same initial conditions has a range $L/2$. The range of particle of mass m and charge $2q$ with the same initial conditions is

- A. L
- B. $L/2$
- C. $L/3$
- D. $L/4$

- 93 Figure below shows a small mass connected to a string, which is attached to a vertical post. If the ball is released when the string is horizontal as shown, the magnitude of the total acceleration (including radial and tangential) of the mass as a function of the angle θ is

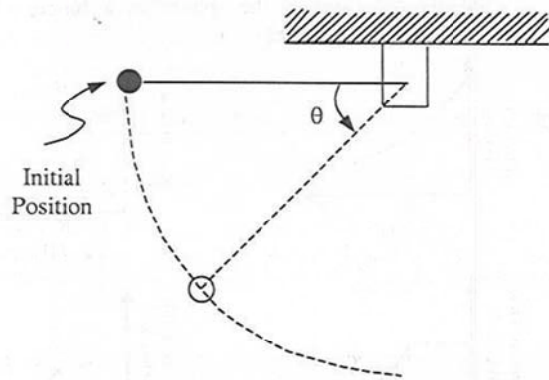

- A. $g \sin \theta$ B. $g\sqrt{3\cos^2\theta + 1}$
 C. $g \cos \theta$ D. $g\sqrt{3\sin^2\theta + 1}$

- 94 One mole of an ideal gas at initial temperature T , undergoes a quasi-static process during which the volume V is doubled. During the process the internal energy U obeys the equation $U = aV^3$, where a is a constant. The work done during this process is

- A. $3RT/2$ B. $5RT/2$
 C. $5RT/3$ D. $7RT/3$

- 95 A constant amount of an ideal gas undergoes the cyclic process ABCA in the PV diagram shown below.

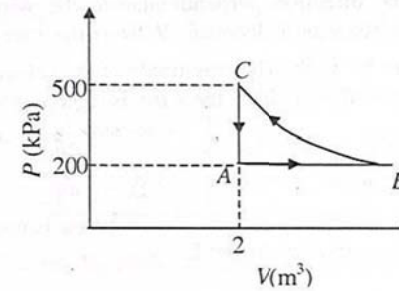

The path BC is an isothermal. The work done by the gas during one complete cycle, beginning and ending at A, is nearly

- A. 600 kJ B. 300 kJ
 C. -300 kJ D. -600 kJ

- 96 A material is embedded between two glass plates. Refractive index n of the material varies with thickness as shown below. The maximum incident angle (in degrees) on the material for which beam will pass through the material is

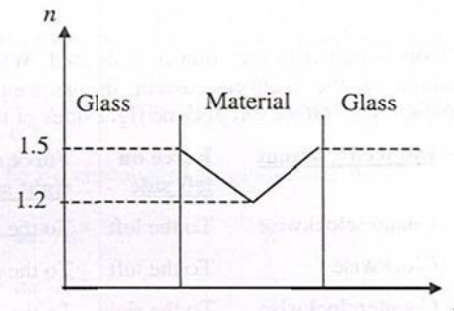

- A. 60.0 B. 53.1
 C. 43.5 D. 32.3

- 97 At a distance l from a uniformly charged long wire, a charged particle is thrown radially outward with a velocity u in the direction perpendicular to the wire. When the particle reaches a distance $2l$ from the wire its speed is found to be $\sqrt{2}u$. The magnitude of the velocity, when it is a distance $4l$ away from the wire, is (ignore gravity)

- A. $\sqrt{3}u$ B. $2u$
 C. $2\sqrt{2}u$ D. $4u$

- 98 A rectangular loop of wire shown below is coplanar with a long wire carrying current I .

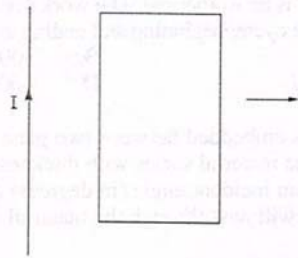

The loop is pulled to the right as indicated. What are the directions of the induced current in the loop and the magnetic forces on the left and the right sides of the loop?

- | | <u>Induced Current</u> | <u>Force on left side</u> | <u>Force on right side</u> |
|----|------------------------|---------------------------|----------------------------|
| A. | Counterclockwise | To the left | To the right |
| B. | Clockwise | To the left | To the right |
| C. | Counterclockwise | To the right | To the left |
| D. | Clockwise | To the right | To the left |

- 99 Two batteries V_1 and V_2 are connected to three resistors as shown below.

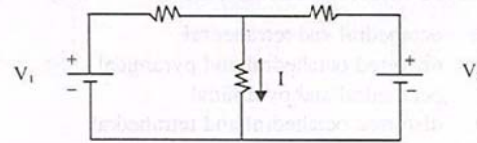

If $V_1 = 2\text{ V}$ and $V_2 = 0\text{ V}$, the current $I = 3\text{ mA}$. If $V_1 = 0\text{ V}$ and $V_2 = 4\text{ V}$, the current $I = 4\text{ mA}$. Now, if $V_1 = 10\text{ V}$ and $V_2 = 10\text{ V}$, the current I will be

- A. 7 mA B. 15 mA
 C. 20 mA D. 25 mA

- 100 A particle moves in a plane along an elliptic path given by

$$\frac{x^2}{a^2} + \frac{y^2}{b^2} = 1.$$

At point $(0, b)$, the x -component of velocity

is u . The y -component of acceleration at this point is

- A. $-bu^2/a^2$ B. $-u^2/b$
 C. $-au^2/b^2$ D. $-u^2/a$

CHEMISTRY

101 XeF_6 hydrolyses to give an oxide. The structures of XeF_6 and the oxide, respectively, are

- A. octahedral and tetrahedral
- B. distorted octahedral and pyramidal
- C. octahedral and pyramidal
- D. distorted octahedral and tetrahedral

102 MnO_4^- oxidizes (i) oxalate ion in acidic medium at 333 K and (ii) HCl. For balanced chemical equations, the ratios $[\text{MnO}_4^- : \text{C}_2\text{O}_4^{2-}]$ in (i) and $[\text{MnO}_4^- : \text{HCl}]$ in (ii), respectively, are

- | | |
|--------------------|--------------------|
| A. 1 : 5 and 2 : 5 | B. 2 : 5 and 1 : 8 |
| C. 2 : 5 and 1 : 5 | D. 5 : 2 and 1 : 8 |

103 If $E_{\text{Fe}^{2+}/\text{Fe}}^\circ = -0.440 \text{ V}$ and $E_{\text{Fe}^{3+}/\text{Fe}^{2+}}^\circ = 0.770 \text{ V}$, then $E_{\text{Fe}^{3+}/\text{Fe}}^\circ$ is

- | | |
|-------------|-------------|
| A. 0.330 V | B. -0.037 V |
| C. -0.330 V | D. -1.210 V |

104 The electron in hydrogen atom is in the first Bohr orbit ($n = 1$). The ratio of transition energies, $E(n = 1 \rightarrow n = 3)$ to $E(n = 1 \rightarrow n = 2)$, is

- | | |
|----------|----------|
| A. 32/27 | B. 16/27 |
| C. 32/9 | D. 8/9 |

105 In the following conversion,

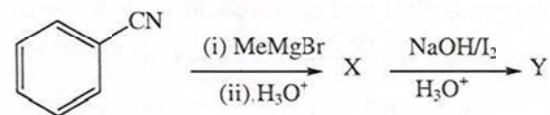

the major products X and Y, respectively, are

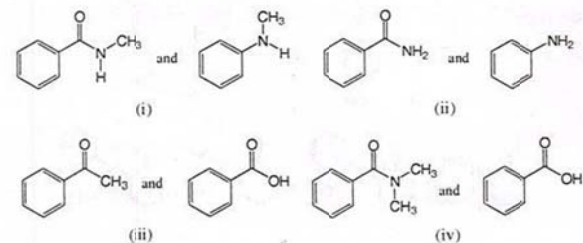

- | | |
|--------|-------|
| A. i | B. ii |
| C. iii | D. iv |

106 In the reaction sequence,

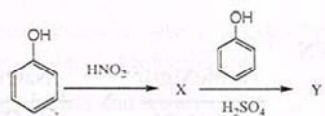

the major products X and Y, respectively, are

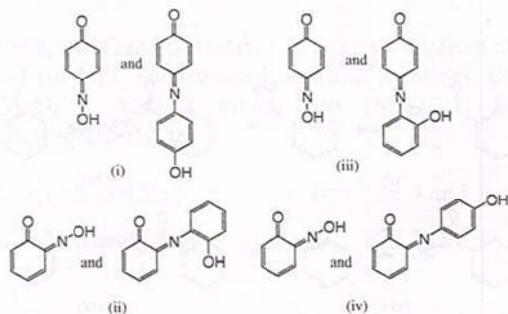

- A. i B. ii
 C. iii D. iv

107 Optically active (S)- α -methoxyacetaldehyde on reaction with MeMgX gave a mixture of alcohols. The major diastereomer 'P' on treatment with $\text{MeI/K}_2\text{CO}_3$ gave an optically inactive compound. P is

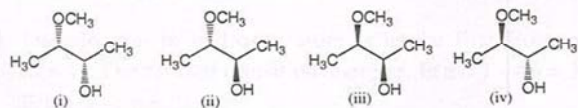

- A. i B. ii
 C. iii D. iv

108 At 300 K the vapour pressures of two pure liquids, A and B are 100 and 500 mm Hg, respectively. If in a mixture of A and B, the vapour pressure is 300 mm Hg, the mole fractions of A in the liquid and in the vapour phase, respectively, are

- A. 1/2 and 1/10 B. 1/4 and 1/6
 C. 1/4 and 1/10 D. 1/2 and 1/6

109 The crystal field stabilization energies (CFSE) of high spin and low spin d^6 metal complexes in terms of Δ_0 , respectively, are

- A. -0.4 and -2.4 B. -2.4 and -0.4
 C. -0.4 and 0.0 D. -2.4 and 0.0

110 Emulsification of 10 ml of oil in water produces 2.4×10^{18} droplets. If the surface tension at the oil-water interface is 0.03 Jm^{-2} and the area of each droplet is $12.5 \times 10^{-16} \text{ m}^2$, the energy spent in the formation of oil droplets is

- A. 90 J B. 30 J
 C. 900 J D. 10 J

BIOLOGY

- 111 Which sequence of events gives rise to flaccid guard cells and stomatal closure at night?
- A. low [Glucose] \Rightarrow low osmotic pressure \Rightarrow low pH \Rightarrow high $p\text{CO}_2$
 - B. low pH \Rightarrow high $p\text{CO}_2$ \Rightarrow low [Glucose] \Rightarrow low osmotic pressure
 - C. low osmotic pressure \Rightarrow high $p\text{CO}_2$ \Rightarrow low pH \Rightarrow low [Glucose]
 - D. high $p\text{CO}_2$ \Rightarrow low pH \Rightarrow low [Glucose] \Rightarrow low osmotic pressure
- 112 Rice has a diploid genome with $2n = 24$. If crossing-over is stopped in a rice plant and then selfed seeds are collected, will all the offsprings be genetically identical to the parent plant?
- A. yes, because crossing-over is the only source of genetic variation
 - B. no, because stopping of crossing-over automatically increases rate of point mutation
 - C. yes, only if the parent plant was a completely inbred line
 - D. yes, only if the parent plant was a hybrid between two pure-bred lines
- 113 Rodents can distinguish between many different types of odours. The basis for odour discrimination is that
- A. they have a small number of odorant receptors that bind to many different odorant molecules
 - B. the mechanoreceptors in the nasal cavity are activated by different odorant molecules found in the air passing through the nostrils
 - C. the part of the brain that processes the sense of smell has many different receptors for odorant molecules
 - D. a large number of different chemoreceptors are present in the nasal cavity that binds a variety of odorant molecules
- 114 Although blood flows through large arteries at high pressure, when the blood reaches small capillaries the pressure decreases because
- A. the valves in the arteries regulate the rate of blood flow into the capillaries
 - B. the volume of blood in the capillaries is much lesser than that in the arteries
 - C. the total cross-sectional area of capillaries arising from an artery is much greater than that of the artery
 - D. elastin fibers in the capillaries help to reduce the arterial pressure

115 *E. coli* about to replicate was pulsed with tritiated thymidine for 5 min and then transferred to normal medium. After one cell division which one of the following observations would be correct?

- A. both the strands of DNA will be radioactive
- B. one strand of DNA will be radioactive
- C. none of the strands will be radioactive
- D. half of one strand of DNA will be radioactive

116 Selection of lysine auxotroph (bacteria which requires lysine for growth) from a mixed population of bacteria can be done by growing the bacterial population in the presence of

- A. lysine
- B. penicillin
- C. lysine and penicillin
- D. glucose

117 Increasing the number of measurements of an experimental variable will

- A. increase the standard error of the sample
- B. increase the mean of the sample
- C. decrease the standard error of the sample
- D. result in all of the above

118 For a human male what is the probability that all the maternal chromosomes will end up in the same gamete?

- A. $1/23$
- B. 2^{23}
- C. 2^{46}
- D. $(1/2)^{23}$

119 Nocturnal animals have retinas that contain

- A. a high percentage of rods to increase sensitivity to low light conditions
- B. a high percentage of cones so that nocturnal color vision can be improved in low light conditions
- C. an equal number of rods and cones so that vision can be optimized
- D. retinas with the photoreceptor layer present in the front of the eye to increase light sensitivity

120 The length of one complete turn of a DNA double helix is

- A. 34 Å
- B. 34 nm
- C. 3.4 Å
- D. 3.4 μm

ROUGH WORK

11. The brain of the guinea pig is shown in the figure below. The brain is divided into several parts. The cerebrum is the largest part of the brain and is responsible for most of the higher functions of the brain. The cerebellum is a smaller part of the brain that is responsible for coordination and balance. The brainstem is the part of the brain that connects the cerebrum and cerebellum to the spinal cord. The brainstem is divided into three parts: the midbrain, the pons, and the medulla oblongata. The medulla oblongata is the part of the brainstem that is continuous with the spinal cord. The medulla oblongata is responsible for many of the basic functions of the body, such as breathing, heart rate, and blood pressure. The medulla oblongata is also responsible for the reflexes of the body. The medulla oblongata is a very important part of the brain and is essential for life.

ROUGH WORK